



# S-BOX

## SEQUENTIAL BOX

SPPC-SB: POWER CONNECTORS 500A / 750A



## About Us



### Radiall

Since 1952, Radiall Sa have been enabling the future through collaboration with our customers. The results are a range of innovative and award-winning products that customers trust for unrivaled repeatability and performance.

Radiall Sa are a global company with facilities around the world that specializes in manufacturing the highest quality interconnect components to support the most demanding applications.

At Radiall, you can rely on us to be the industry's global market leader.

### VanSystem

VanSystem is a company founded in Lombardy - Italy, which has been operating since 1985 in the industrial market. Since 2015 VanSystem is a Radiall company.

Besides connectors with screw or bayonet coupling complying with the Mil-DTL-5015 standard, VanSystem designs and manufactures non-standard products for special applications. One of VanSystem's strong points is an agile and dynamic organizational structure which enables direct and constant interaction with customers in order to meet all their requirements and build solid, long-term partnerships. The VanSystem team's professionalism, skill and commitment are at your service to help you achieve the solution you are looking for.

VanSystem's Quality System is qualified according to ISO 9001:2015 and ISO/TS 22163:2017 IRIS Certification™ rules:2017 (International Railway Industry Standard).



# S-BOX - Introduction

## Sequential Box



### Distribution Box for Power Connectors:

Single Pole Power Connectors have become widely adopted in a diverse range of applications and industries.

S-BOX distribution box has been developed to guarantee greater safety in use. The connectors can only be inserted in sequence, on mating the final connector a non standard key locks the connectors in place.

The main features are:

- Polarisation system to prevent connection errors
- Up to 750 A, 1.000 V
- From 35 mm<sup>2</sup> to 300 mm<sup>2</sup> wire section
- IP67 when mated (according to EN 60529)
- Finger Protected IP2x: pin and socket contacts
- Multi-louver contact system

### APPLICATIONS:

- Power distribution
- Utilities
- Electric Vehicles
- Railway Equipment
- Military Field Power
- Mobile Generators
- Loadbanks
- Back-up Power Systems

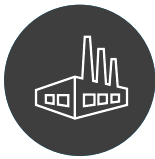

### FEATURES AND BENEFITS:

- Sequential connecting ensures Ground/Earth is connected first
- Colour coding for ease of use.
- Mechanical keying to prevent incorrect mating of phases or earth and neutral.
- The metal box guarantees greater strength to mechanical shocks and resistance to mechanical shock and vibration.

Safety notice: S-Box should only be installed and operated by suitably qualified persons.



## S-BOX - Introduction

### Sequential Box - Features

S-BOX has been developed for use in high current installations in order to avoid disconnecting under load. Connectors are keyed and must be connected in sequence from Earth through to Line 3. The connectors can be locked and the power connected to a micro switch to ensure power flows only when everything is properly connected.



S-BOX has many security advantages if compared to individual panel connectors:

- Sequential connecting ensures ground is connected first and the non standard key locks the connectors to prevent unmating under load.
- All connectors are “keyed” to avoid cross mating.
- An M12 connector can be activated or de-activated on the locking of the non standard triangular key.
- Color coded to suit international standard.



# S-BOX - Introduction

## Sequential Box - Features

### Fixing Holes

- Interchangeability (R 44,45 mm) modular 19".
- 2U Rack mounting (S 76,2 mm)

Robust metal frame resilient to mechanical shocks and vibration

Optional flange version with protective gasket



Sealed Caps IP65 (protection degree)

Visual indication of switch position

Finger protected IP2X: drain and source contacts.



IP2X Touch Proof protection

## S-BOX - Introduction

### Sequential Box - Features

The S-BOX can be supplied with different contact types:

- Threaded Post/Hole Contacts up to 150mm<sup>2</sup> - 500A / up to 300mm<sup>2</sup> - 750A.
- Crimp Contacts up to 300mm<sup>2</sup> - 750A.
- Screw Terminal Contacts up to 150mm<sup>2</sup> - 500A

Rated current: 500A (silver plated brass contacts) - 750A (silver plated copper contacts)



External grounding contacts    M12 connector internally wired with microswitch    M12 Threaded hole    M12 Threaded post    Rear adaptor with M40 Cable Gland



Screw terminal    Crimp contacts

## S-BOX - Introduction

### Sequential Box - Features

An optional backshell and cable gland gives IP67 protection at the rear (for use with screw terminal or crimp contacts).



The S-BOX may be mounted into standard modular 19" rack systems or in panel mounts.

Using sealing caps does not alter the height. One box can be mounted directly above another.

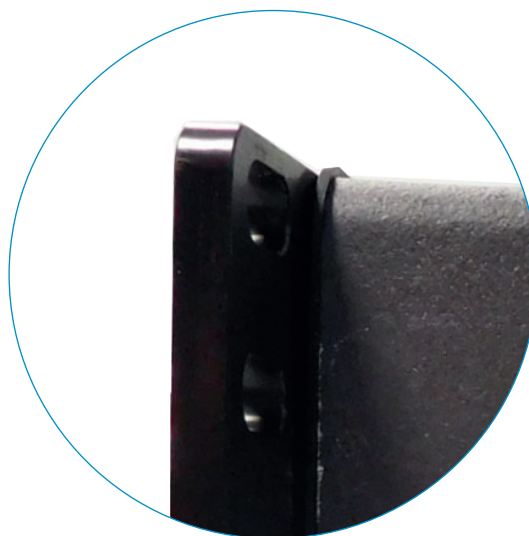

# S-BOX - Introduction

## Sequential Box

### SEQUENTIAL BOX OPERATING INSTRUCTIONS:

Connection of Sequential Box connectors is made sequentially, starting with Ground / Earth connection (Green) and working to the right.

- Insert the Ground (Green) connector, aligning the Plug connector arrow on the label of the connector in a 12 o'clock position. Fully insert the connector until it bottoms out and turn until the connector stops.
- Repeat for the Neutral connector, followed in order by L1, L2, and L3.
- Lock the connectors, using the triangular drive key provided, the lock is situated adjacent to the L3 connection.
- Remove the key. All connectors are now locked in place and can be removed only when the box is unlocked.
- The power must be turned off and reverse the above procedure, to remove the connectors.

1

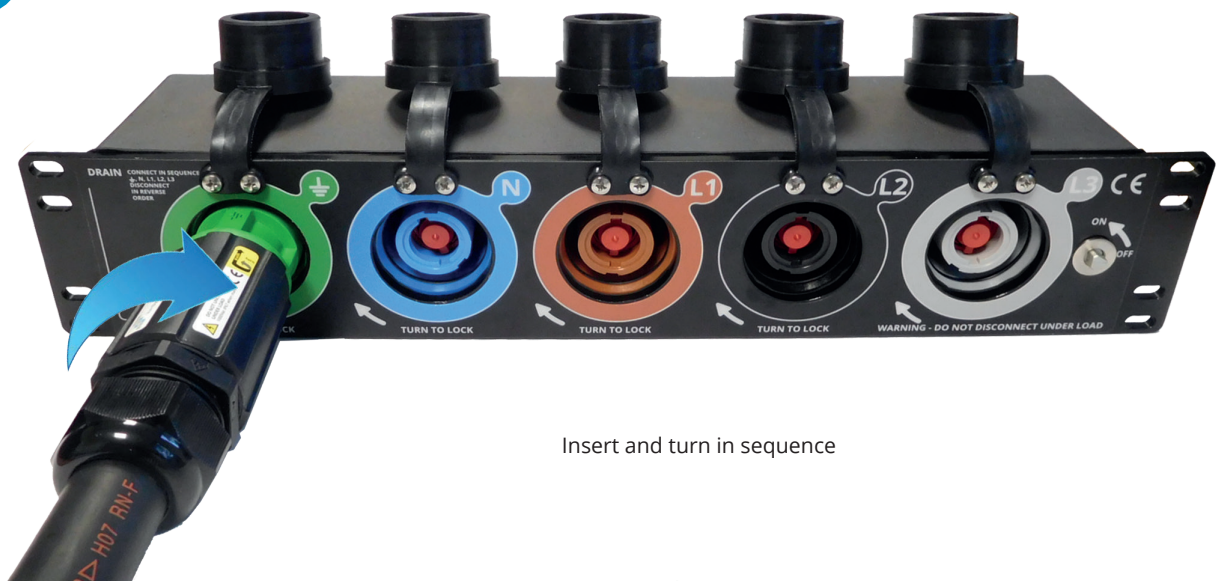

Insert and turn in sequence

2



The last connector lock the previous one



# S-BOX - Introduction

## Sequential Box

3

Lock the connectors and switch on the microswitch by locking using the triangular key.



You can use the SPPC-PWL2.0 connectors and the SPPC-PWL connectors as well as compatible versions.



# S-BOX - Introduction

## Sequential Box

### M12 CONNECTOR:

3 Pole M12 is located on the rear of the unit to provide a remote monitoring function of equipment status but it cannot be the only safety guarantee.

The M12 connector installed on the rear is connected to a microswitch inside the unit, the microswitch is activated using the triangular key.

The connector body has 4 poles with 3 contacts wired to the switch. Using 3 poles, the cable connector can be wired to suit your requirements, either "Normally Open" or "Normally Closed" or both.

The microswitch cannot be used to switch off the voltage power.

### Do not disconnect under load.



Contact Position	ON	OFF
1	Common	Common
2	Open	Closed
3	Closed	Open
4	Not Used	Not Used

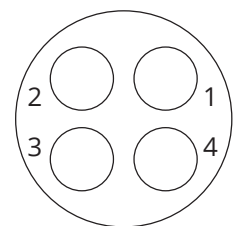

### PACKAGING:

The carton box and internal packing are recyclable and should be disposed of separately.

### PACKAGING CONTENTS:

The packaging contains the following components:

QTY	COMPONENTS
1	Sequential Box
3 or 5	SPPC Contacts (according to the number of connectors)
1	Triangular key
1	3 pole M12 cable connector
1	Operating / Maintenance guide

# S-BOX - Introduction

## Sequential Box

### CHARACTERISTICS:

Current rating	500A or 750A (check label for rating)
Voltage rating	1000V
Microswitch operating voltage	250Vac / 30Vdc max.
Microswitch current rating	4A (Resistive Load) / 0,5A (Lamp Load)
Operating temperature	-30°C to +85°C
Environmental protection	IP67 (when mated connectors and locked) IP65 (when caps are closed) IP2X (finger protected)
Sequential Box weight	Unit with rubber caps: 4.70 Kg approx Unit without caps: 4.35 Kg approx
Flammability rating	UL94-V0
Endurance	500 connection cycles

### ELECTRICAL INSTALLATION:

The connection to back of the unit is:

- Threaded Post/Hole Contacts up to 150mm<sup>2</sup> - 500A / up to 300mm<sup>2</sup> - 750A.
- Crimp Contacts up to 300mm<sup>2</sup> - 750A.
- Screw Terminal Contacts up to 150mm<sup>2</sup> - 500A

### SAFETY PRECAUTIONS:

- Use the connectors and connected cables within their electrical and environmental limits
- Each position is marked on the front of the box, E (Ground), N, L1, L2, & L3 (or +,-).
- The threaded post contacts have a spring washer and nut that should be tightened to a torque of 30Nm max.
- The screw terminal contacts should be tightened to a torque of 12Nm max.
- Cable connections: Threaded Post/Hole on the rear of the unit are for connecting power cables fitted with cable lugs.
- It is recommended that insulated spanners and correct tools are used when making the connections and installations.
- The shell of S-Box must be connected to the rear ground connection (M6).
- After wiring it is necessary to verify the continuity of the protective earth connections.

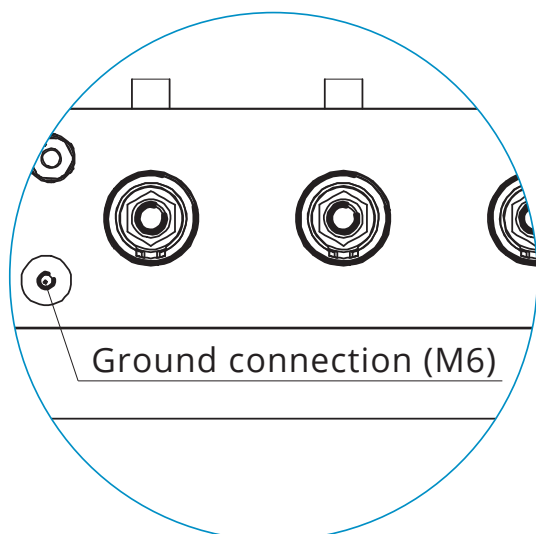

# S-BOX - Dimensions

## Panel Drain Connectors

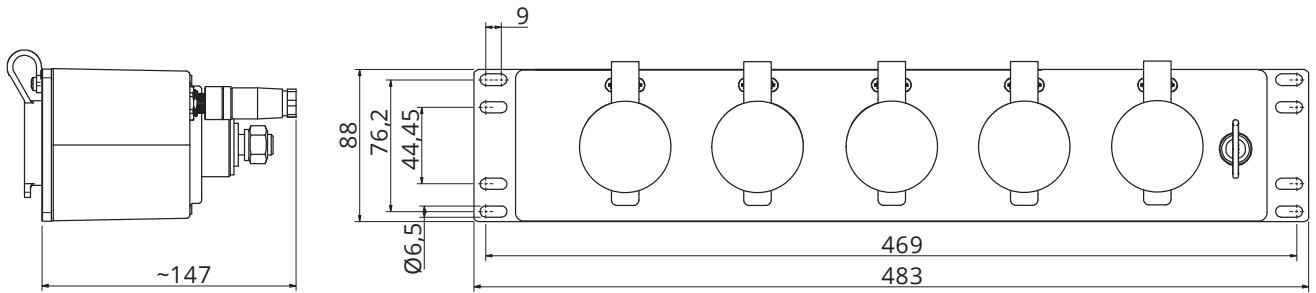

with caps

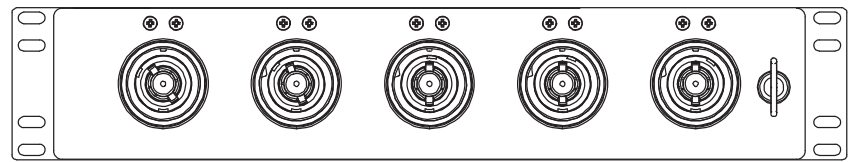
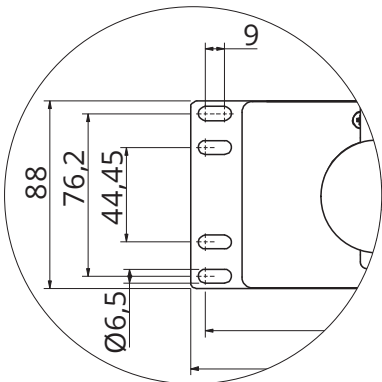

without caps

### M12 Threaded post version

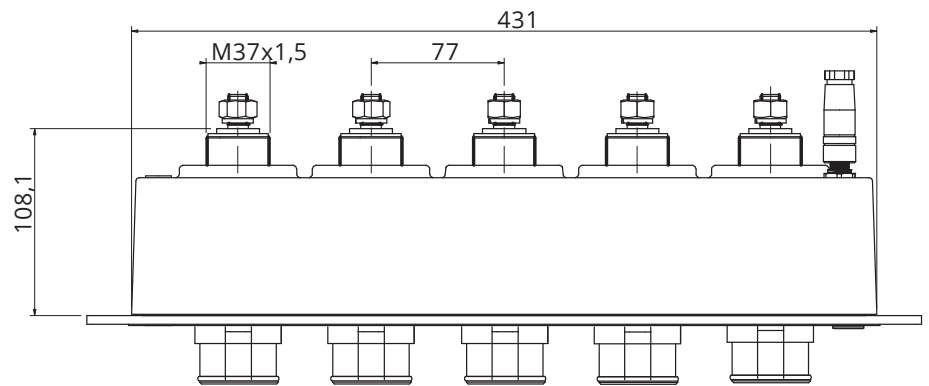

### M12 Threaded hole post version

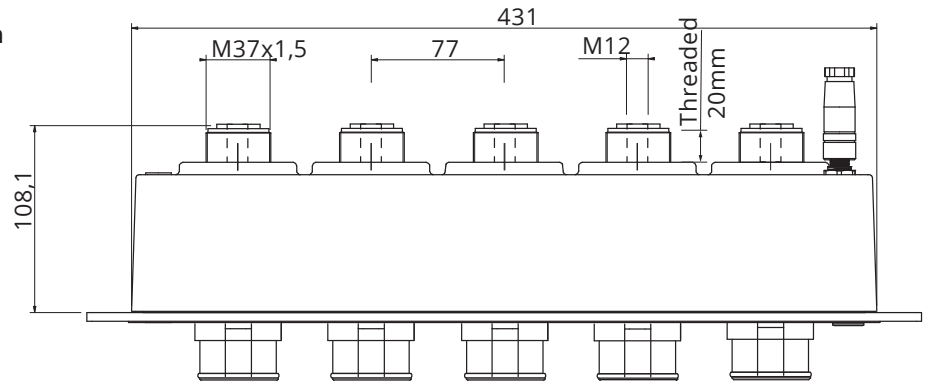

Dimension in mm

# S-BOX - Dimensions

## Panel Source Connectors

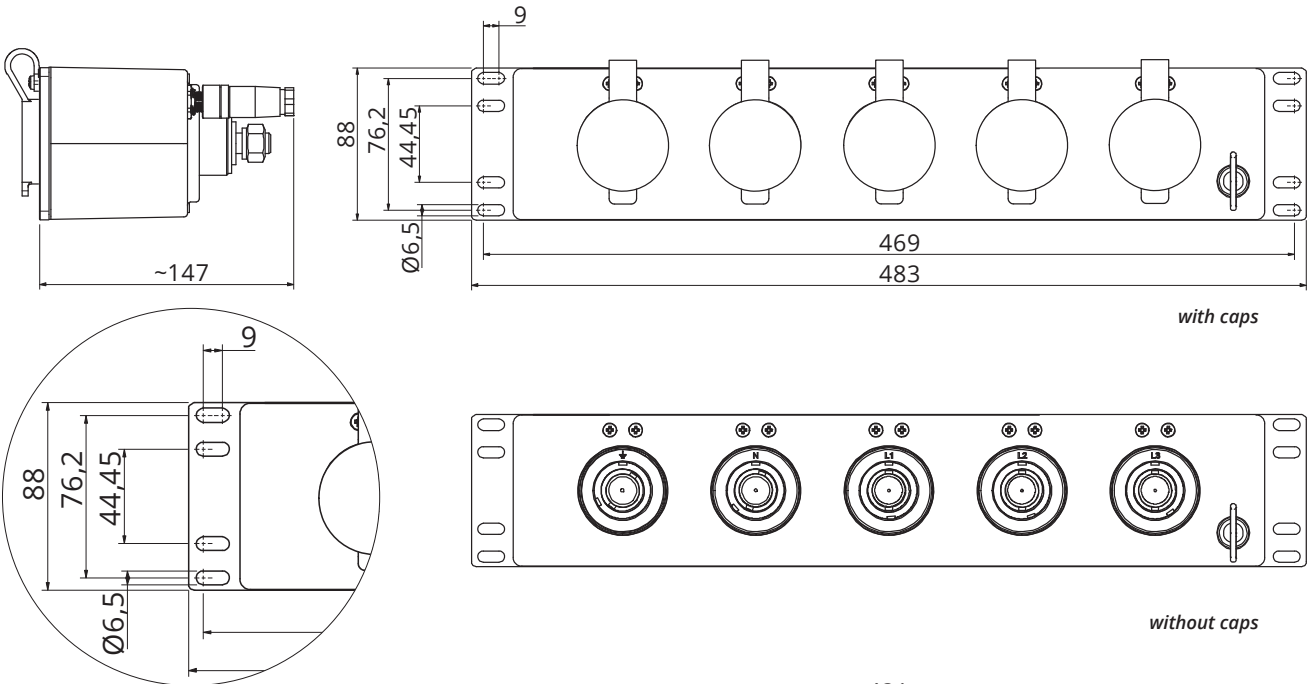

**M12 Threaded post version**

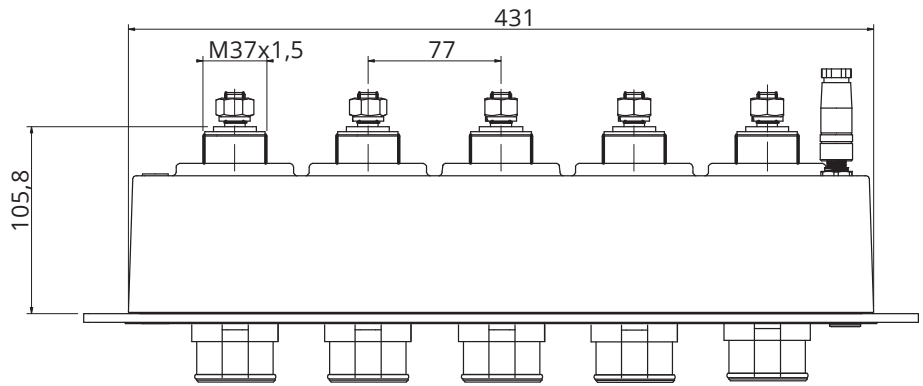

**M12 Threaded hole post version**

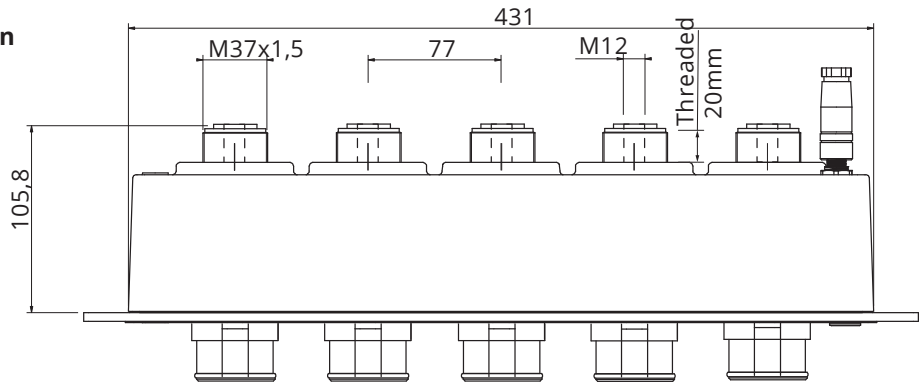

Dimension in mm

# S-BOX - Dimensions - Flanged Version

## Panel Drain Connectors

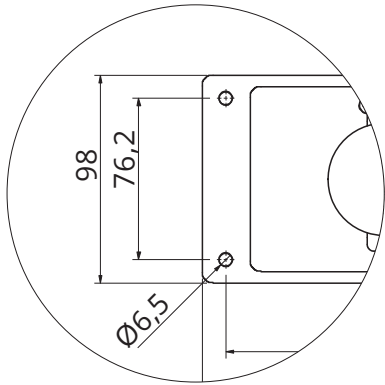
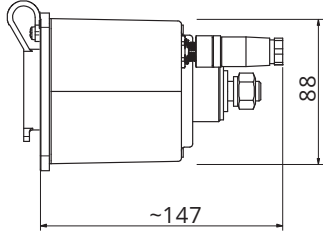

**M12 Threaded post version**

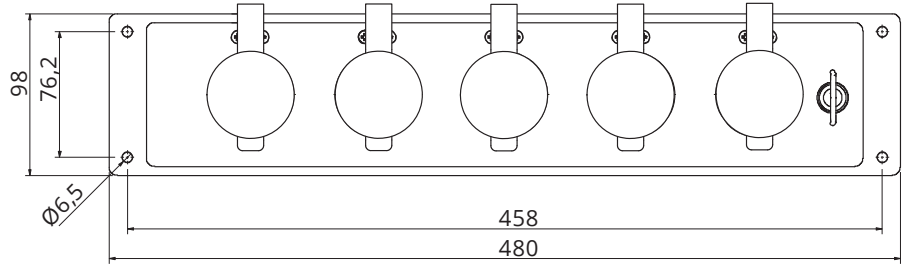

*with caps*

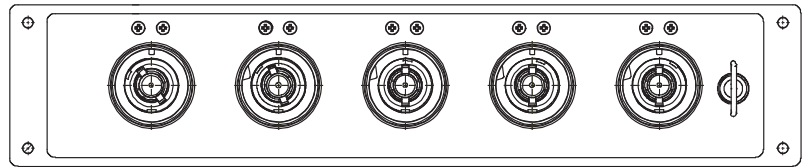

*without caps*

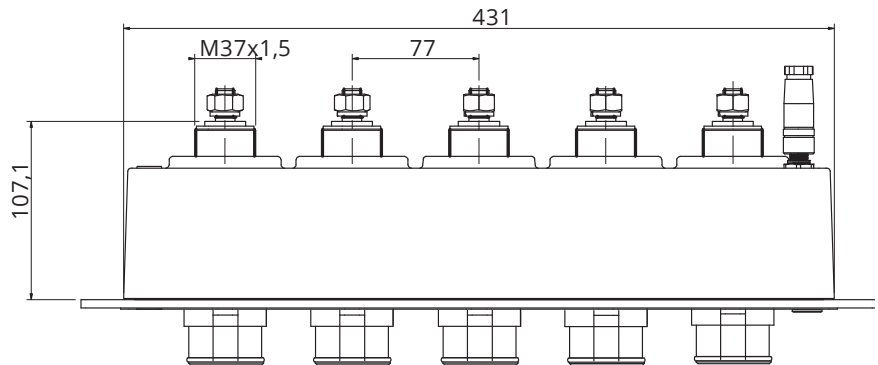

**M12 Threaded hole post version**

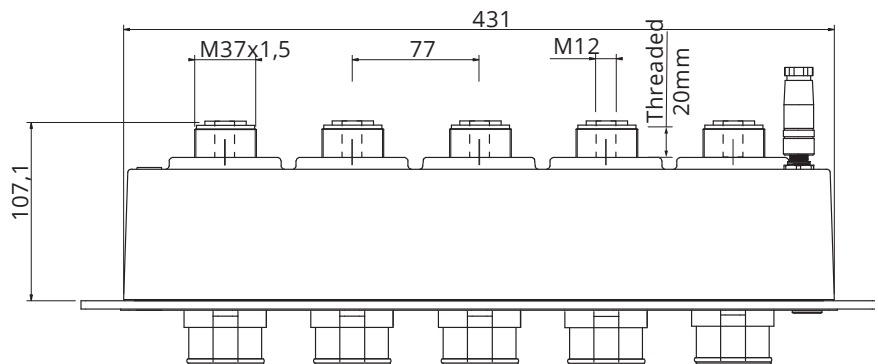

Dimension in mm

# S-BOX - Dimensions - Flanged Version

## Panel Source Connectors

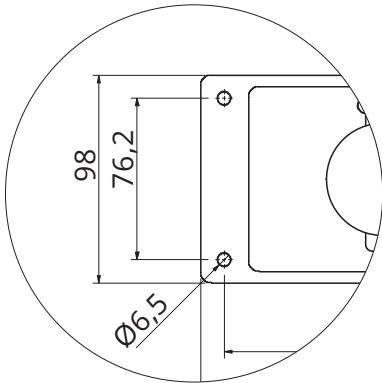
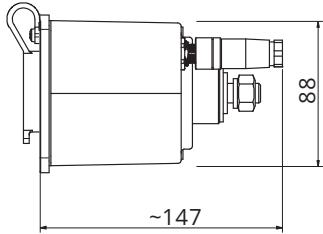

**M12 Threaded post version**

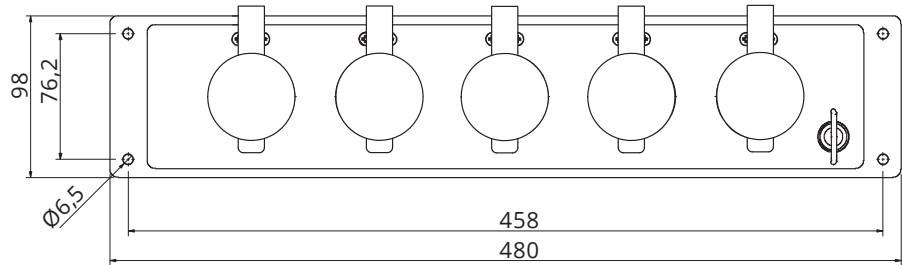

*with caps*

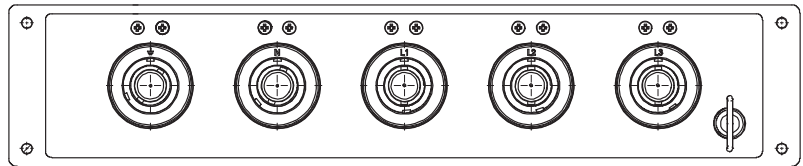

*without caps*

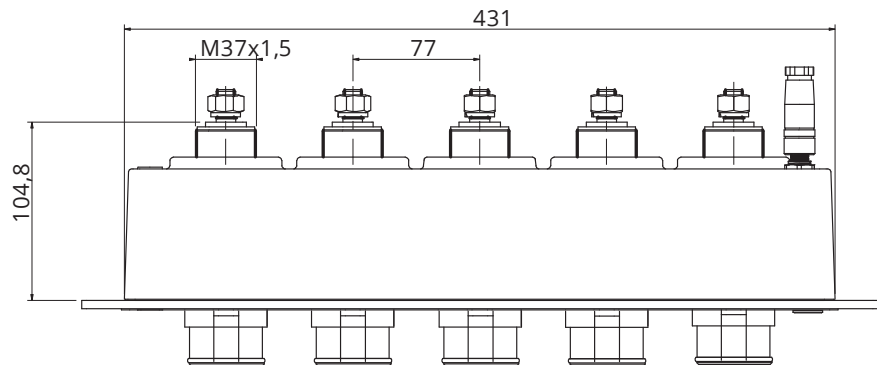

**M12 Threaded hole post version**

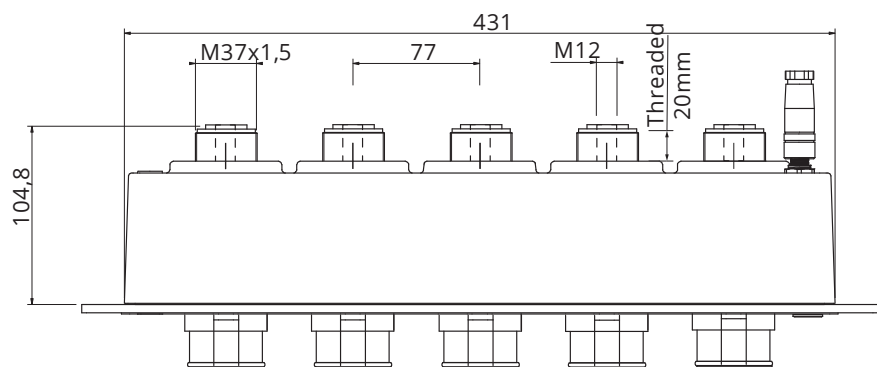

Dimension in mm

## S-BOX - Mounting Instructions

**Attention:** ensure the unit is adequately supported during mounting / dismounting and in normal use.

It is recommended that M6 screws/bolts and flat washers are used, and tightened to a recommended torque (check it with the screws/bolts manufacturer).

### PANEL CUT OUT FOR FLANGED TYPE:

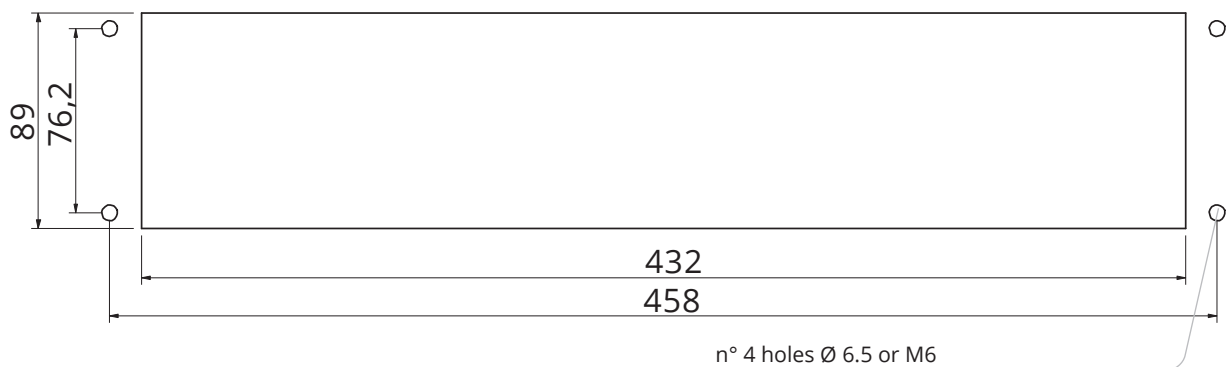

M12 connector

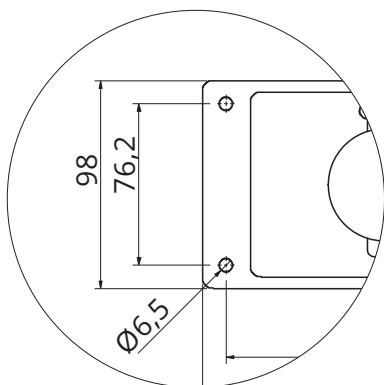
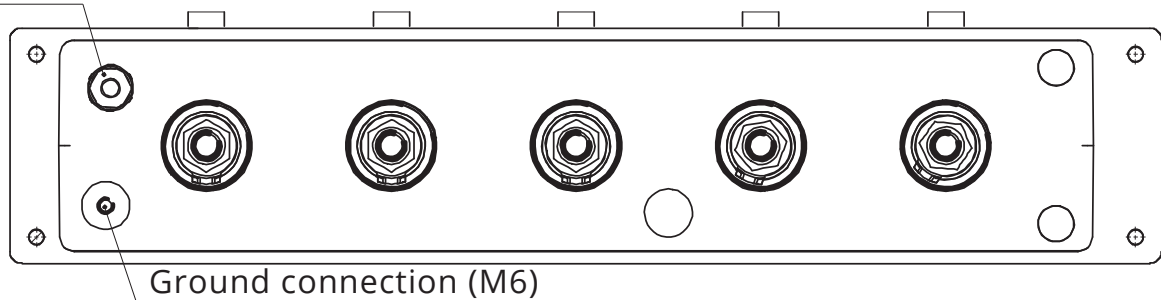



## S-BOX - Part number explanation



P/N Sample: SPPC-SB-PD-EU-L-TH7

<b>SPPC-SB</b>	<b>Series Code</b>	<b>SPPC-SB</b>	Single Pole Power connectors - Sequential Box
<b>PD</b>	<b>Connector Type</b>	<b>PS</b>	Panel Source
		<b>PD</b>	Panel Drain
<b>EU</b>	<b>Insulator color</b>	<b>EU</b>	European 5 Connectors (3P+N+E)
		<b>EU4</b>	European 4 Connectors (3P+E)
		<b>DC</b>	Direct current
<b>L</b>	<b>Caps</b>	-	Without caps
		<b>L</b>	With rubber caps
<b>TH7</b>	<b>Contact Termination</b>	<b>M12-T7</b>	M12 Threaded post - 750A
		<b>M12-T4</b>	M12 Threaded post - 500A
		<b>S-120</b>	Screw terminal - 500A up to 150mm <sup>2</sup> ( Maximum diameter 16.5mm)
		<b>C-35</b>	Crimp contacts - 500A 35mm <sup>2</sup>
		<b>C-50</b>	Crimp contacts - 500A 50mm <sup>2</sup>
		<b>C-70</b>	Crimp contacts - 500A 70mm <sup>2</sup>
		<b>C-95</b>	Crimp contacts - 500A 95mm <sup>2</sup>
		<b>C-120</b>	Crimp contacts - 500A 120mm <sup>2</sup>
		<b>C-150</b>	Crimp contacts - 500A 150mm <sup>2</sup>
		<b>C-185</b>	Crimp contacts - 750A 185mm <sup>2</sup>
		<b>C-240</b>	Crimp contacts - 750A 240mm <sup>2</sup>
		<b>C-300</b>	Crimp contacts - 750A 300mm <sup>2</sup>
		<b>TH7</b>	Threaded hole - 750A
		<b>TH4</b>	Threaded hole - 500A
<b>PM</b>	<b>Mounting Type</b>	-	Modular 19" rack version
		<b>PM</b>	Panel mounting

### COLOUR CODING

Standard	Earth	Neutral	Phase L1	Phase L2	Phase L3
Europe	Green (GN)	Blue (BU)	Brown (BR)	Black (BK)	Grey (GY)
Direct current DC	Green (GN)	Black (BK)	-	Red (RD)	-

## S-BOX - Panel Drain Connectors with rubber caps



*\*European Harmonized Color Set, others colors set on request*

### 750A

#### M12 Threaded post, copper contacts

Color*	Short Description	Part Number
European	SPPC-SB-PD-EU-L-M12-T7	VS398905



### 500A

#### M12 Threaded post, brass contacts

Color*	Short Description	Part Number
European	SPPC-SB-PD-EU-L-M12-T4	VS398906



### 750A

#### M12 Threaded hole, copper contacts

Color*	Short Description	Part Number
European	SPPC-SB-PD-EU-L-TH7	VS398901

### 500A

#### M12 Threaded hole, brass contacts

Color*	Short Description	Part Number
European	SPPC-SB-PD-EU-L-TH4	VS398902

## S-BOX - Panel Source Connectors with rubber caps



\*European Harmonized Color Set, others colors set on request



### 750A M12 Threaded post, copper contacts

Color*	Short Description	Part Number
European	SPPC-SB-PS-EU-L-M12-T7	VS398907

### 500A M12 Threaded post, brass contacts

Color*	Short Description	Part Number
European	SPPC-SB-PS-EU-L-M12-T4	VS398908



### 750A M12 Threaded hole, copper contacts

Color*	Short Description	Part Number
European	SPPC-SB-PS-EU-L-TH7	VS398903

### 500A M12 Threaded hole, brass contacts

Color*	Short Description	Part Number
European	SPPC-SB-PS-EU-L-TH4	VS398904

## S-BOX - Panel Drain Connectors with rubber caps - Flanged Version

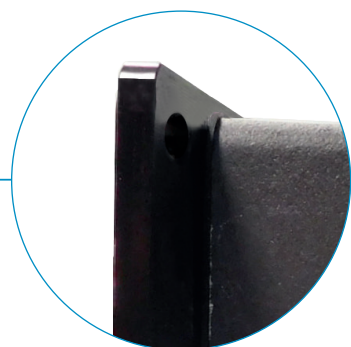

*\*European Harmonized Color Set, others colors set on request*



### 750A M12 Threaded post, copper contacts

Color*	Short Description	Part Number
European	SPPC-SB-PD-EU-L-M12-T7-PM	On Request

### 500A M12 Threaded post, brass contacts

Color*	Short Description	Part Number
European	SPPC-SB-PD-EU-L-M12-T4-PM	On Request



### 750A M12 Threaded hole, copper contacts

Color*	Short Description	Part Number
European	SPPC-SB-PD-EU-L-TH7-PM	On Request

### 500A M12 Threaded hole, brass contacts

Color*	Short Description	Part Number
European	SPPC-SB-PD-EU-L-TH4-PM	On Request

# S-BOX - Panel Source Connectors with rubber caps - Flanged Version

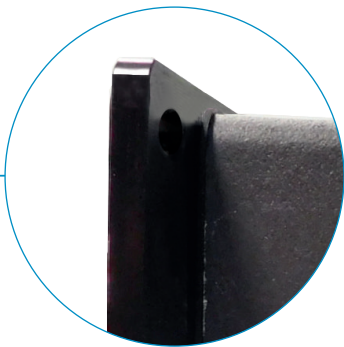

*\*European Harmonized Color Set, others colors set on request*



## 750A M12 Threaded post, copper contacts

Color*	Short Description	Part Number
European	SPPC-SB-PS-EU-L-M12-T7-PM	On Request

## 500A M12 Threaded post, brass contacts

Color*	Short Description	Part Number
European	SPPC-SB-PS-EU-L-M12-T4-PM	On Request



## 750A M12 Threaded hole, copper contacts

Color*	Short Description	Part Number
European	SPPC-SB-PS-EU-L-TH7-PM	On Request

## 500A M12 Threaded hole, brass contacts

Color*	Short Description	Part Number
European	SPPC-SB-PS-EU-L-TH4-PM	On Request

## S-BOX Connectors - Accessories



### Rear Adapter with M40 Cable Gland

Wire section	Short Description	Part Number
19mm – 28mm	SPPC-SB-CG-M	On Request
22mm – 32mm	SPPC-SB-CG-OS	On Request

*Can be used with screw terminal and crimp contacts only*



### Caps

	Short Description	Part Number
for S-BOX panel drain	SPPC-SB-PD-L	On Request
for S-BOX panel source	SPPC-SB-PS-L	On Request

# S-BOX Connectors

## Reference Data for Cable Selection

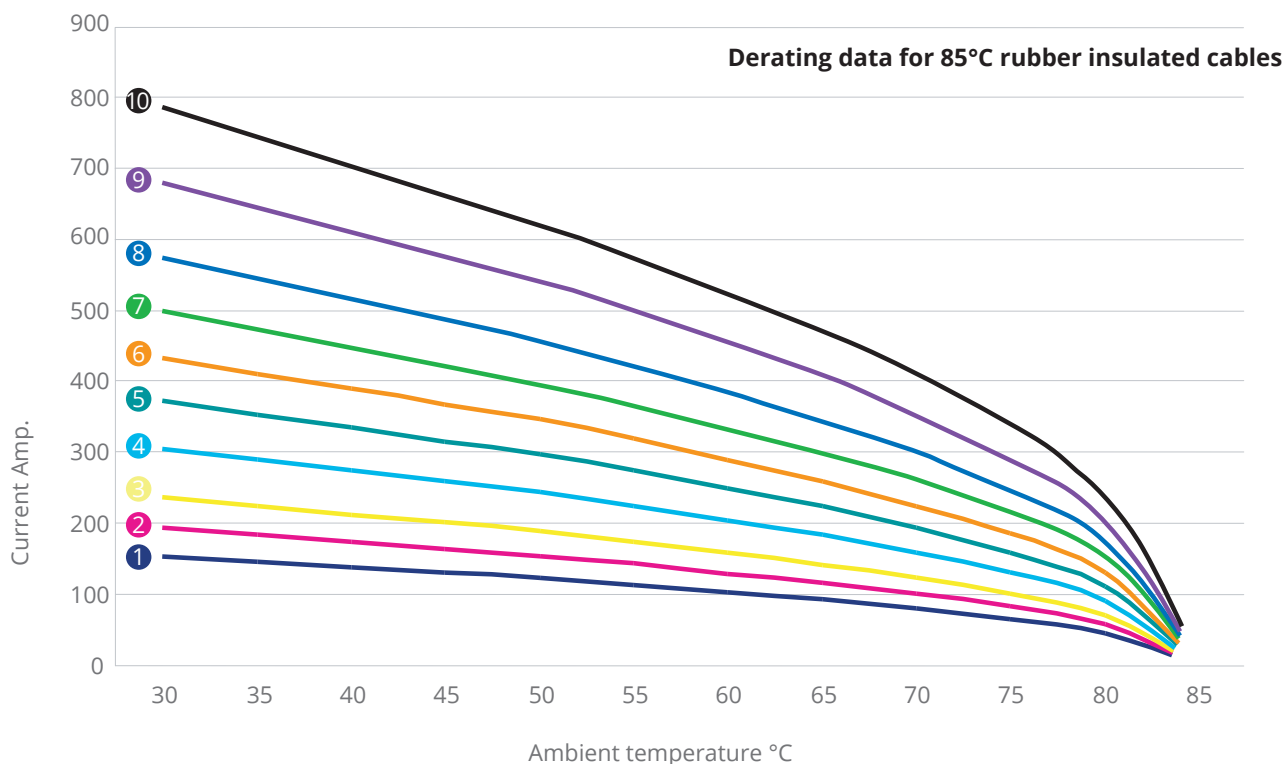

① 25mm² ② 35mm² ③ 50mm² ④ 70mm² ⑤ 95mm² ⑥ 120mm² ⑦ 150mm² ⑧ 185mm² ⑨ 240mm² ⑩ 300mm²

### Characteristics

Screws Tightening Torque (in-line connectors)	12Nm
Panel Contact Tightening Torque	30Nm max
Cable Gland Tightening Torque	13Nm
Minimum Mating Cycles	500
Contact Retention in Insulator	2.5kN Axial Load
Flammability	UL94 V0
Environmental Sealing (when mated)	IP67
Rated Voltage to Earth	2000Vac
Minimum Flashover (EN60309-1)	6.8kV AC – 1 minute
Minimum Insulation Resistance	5GΩ @ 500V
Operating Voltage	1000V AC or DC
Test Voltage (Mated Condition)	5 kV- 1 minute @ 50Hz
Contact Resistance	<0.1mΩ
Short Circuit Current – 1 second	16kA
Short Circuit Current – 3 seconds	12kA
Surge Current (DIN VDE 0102/1.90)	62kA – 10mseconds
Creepage Distance	>25mm
Clearance Distance	>25mm
Temperature Range	-30°C / +125°C

# S-BOX Connectors - Crimping Tool

## Installation Instructions:

- Select proper contacts for the copper wire size used.
- Strip the cable insulation as indicated in the table
- Insert conductor into the barrel.
- Select the proper die as indicated in the table.
- It is recommended to apply multiple crimp compressions in accordance with the above table to obtain optimum mechanical and electrical performance.

The correct sequence of compressions is shown in Fig.2.

Use the following tool:

- Hand operated crimp tool: HT131-C
- Cordless Hydraulic Crimp Tool: B131-C

Due to the numerous cable types available, it is recommended to contact our Customer Service to confirm cable & crimp suitability.

Cable Size	Up to	185mm <sup>2</sup>	240mm <sup>2</sup>	300mm <sup>2</sup>	150 ÷ 185mm <sup>2</sup>	240mm <sup>2</sup>	240 ÷ 300mm <sup>2</sup>
	120mm <sup>2</sup>	low stranded wire			fine stranded wire		
Insulation Strip (dim L)	33mm	40mm	40mm	40mm	40mm	40mm	40mm
Recommended Number of Crimps	N/A (set screw)	1/2	3	3	1/2	3	3
Hand Operated Crimp Tool	N/A	HT120 HT131-C	HT120 HT131-C	HT120 HT131-C	HT120 HT131-C	HT120 HT131-C	HT120 HT131-C
Crimp Die Set	N/A	ME37-C (1) ME48-C (2)	ME60-C	ME60-C	ME37-C (1) ME48-C (2)	ME60-C	ME60-C
Contact Removal Tool	VS390038	VS390039	VS390039	VS390039	VS390039	VS390039	VS390039

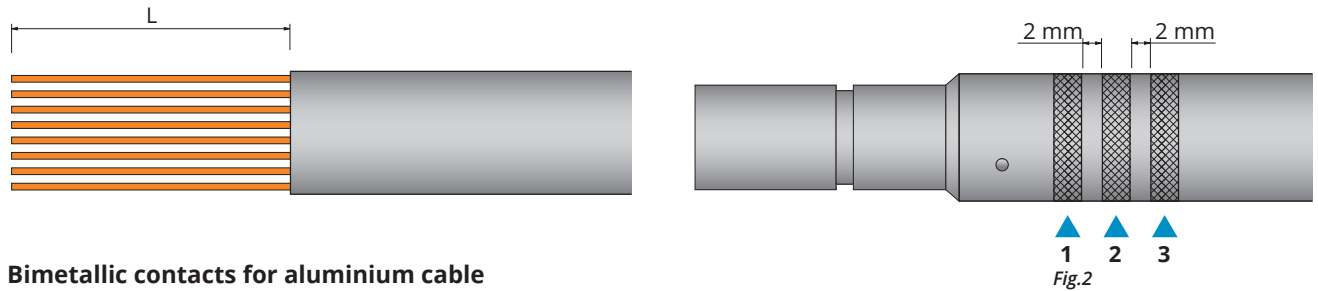

## Bimetallic contacts for aluminium cable

Cable Size	70mm <sup>2</sup>	120mm <sup>2</sup>	150mm <sup>2</sup>	185mm <sup>2</sup>	240mm <sup>2</sup>	300mm <sup>2</sup>
		fine stranded wire				
Hand Operated Crimp Tool	***	HT120 HT131-C	HT120 HT131-C	HT120 HT131-C	ECW-H3D*	ECW-H3D*
Crimp Die Set	***	ME48-C	ME48-C	ME60-C	MK32-3D	MK32-3D
Contact Removal Tool	VS390039	VS390039	VS390039	VS390039	VS390460	VS390460
Recommended Number of crimp	2	2	2	2	3	3
Anti-oxidant compound**	VS390461	VS390461	VS390461	VS390461	VS390461	VS390461

\* For the its operation it is necessary to combine it to a hydraulic pump

\*\* It is recommended to cover the internal walls of the contact hole (suitable for receiving the cable conductor) with the antioxidant compound

\*\*\* Consult our sales office



Hydraulic pump ECW-H3D



Hand Operated Crimp Tool HT131-C



## S-BOX Connectors - Removal Tool



Type	Short Description	Part Number
Screw set termination	SPPC-PWL-RT-25-120	VS390038
Crimp contacts	SPPC-PWL-RT-185-300	VS390039

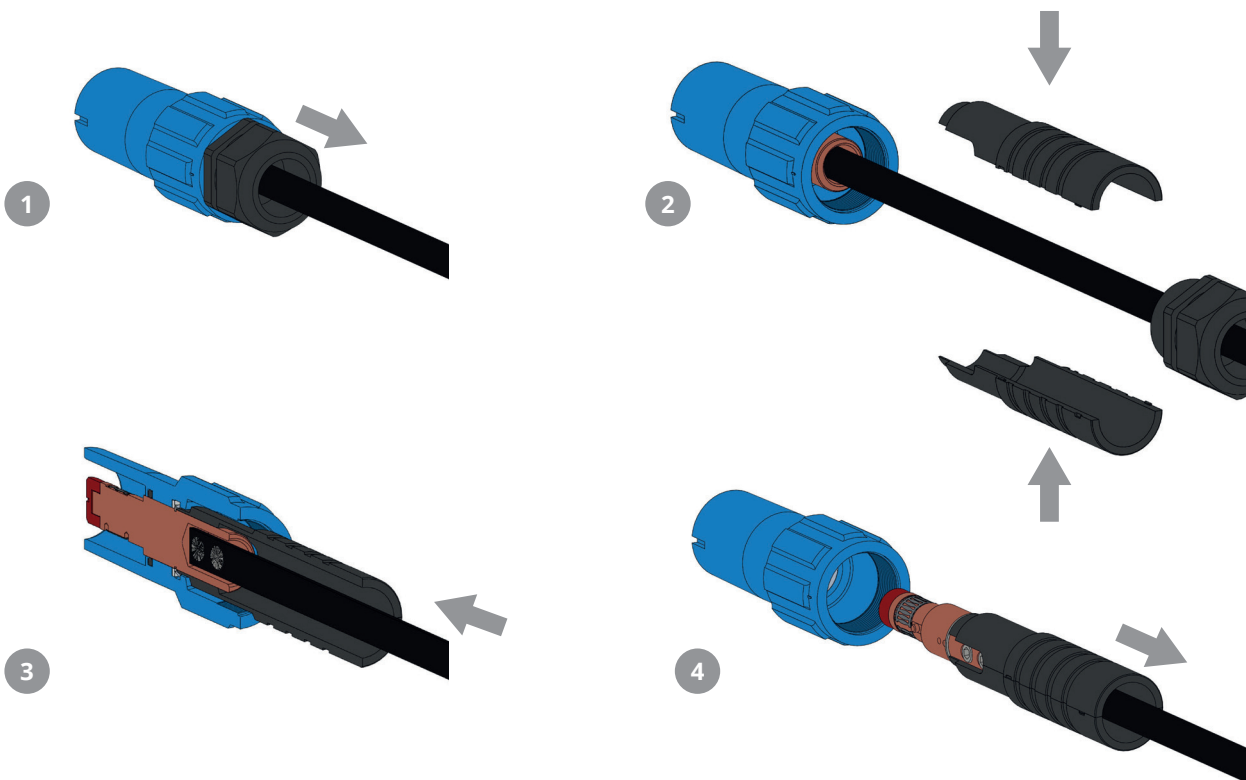

## S-BOX Connectors - Special Version

Other Versions are supplied on request:

- DC

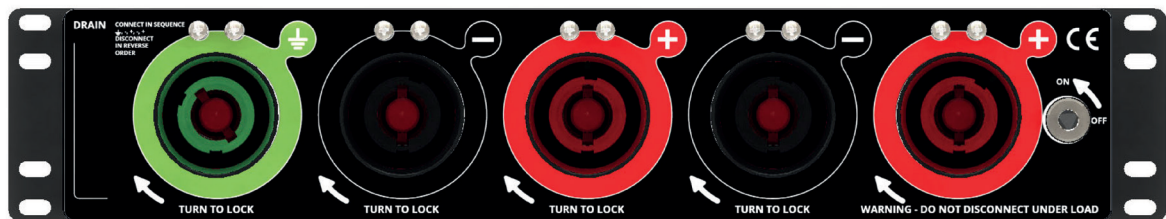
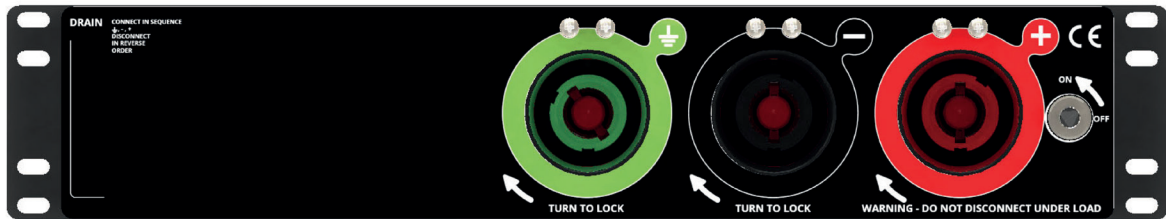

- AC: 3 Poles + Earth (EU4)

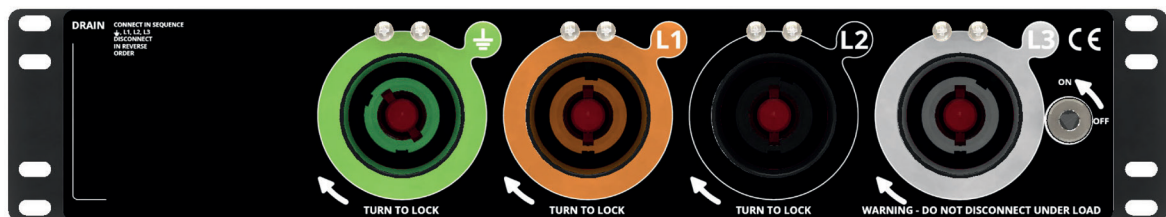

## Information regarding the use of the product within recommended safety limits

To use the connectors described in this instruction according to the necessary safety requirements we suggest you apply the following criteria:

- use the connectors and connected cables within their electrical and environmental limits
- follow the characteristics of each version and carefully choose the appropriate connector for the required use
- make sure to respect the procedures regarding the correct assembly of connectors and the crimping of contacts
- any connector damaged during shipment, storage, assembly or use should be replaced
- never uncouple the connectors when under power
- always protect the parts against shock when the circuit is under power
- always check the circuit before putting it under power
- the user must take final responsibility for electrical safety.

For the instructions concerning assembly and crimping of contacts please consult the appropriate tools manuals.

We recommend to respect the following general rules:

- Always use the tools recommended by Radiall VanSystem's catalogue or manuals
- Use the suggested norms for tool maintenance and calibration

Consult Radiall VanSystem Srl if in doubt.

DO NOT USE ALTERNATIVE GREASES OR OILS which could damage the Sequential Box and affect the functionality of the connector. Radiall VanSystem Srl reserves the right to amend the specifications of this instruction without issuing prior notice.

### SAFETY PRECAUTIONS:

Carefully read the safety instructions before using S-Box product.

- Make sure that the current of the cables and connectors being used are suitable for the S-Box current rating.
- The cables must not be connected under voltage.
- Connectors must not be connected or disconnected when live or under load. The voltage power must be switched off before connection/disconnection.
- The contacts must be checked before assembly to ensure there is no damage on them before starting the next assembly step.

*The data defined in this document are given as an indication. In the effort to improve our products, we reserve the right to make any change judged necessary.*



[www.radiall.com](http://www.radiall.com)

**FRANCE**

RADIALL S.A.  
Tel +33149353535  
[info@radiall.com](mailto:info@radiall.com)



[www.vansystem.eu](http://www.vansystem.eu)

**ITALY**

Radiall VanSystem S.r.l.  
Tel. +39023569931  
[info.vansystem@radiall.com](mailto:info.vansystem@radiall.com)