

# DATA TRANSMISSION

industrial BUS connectors

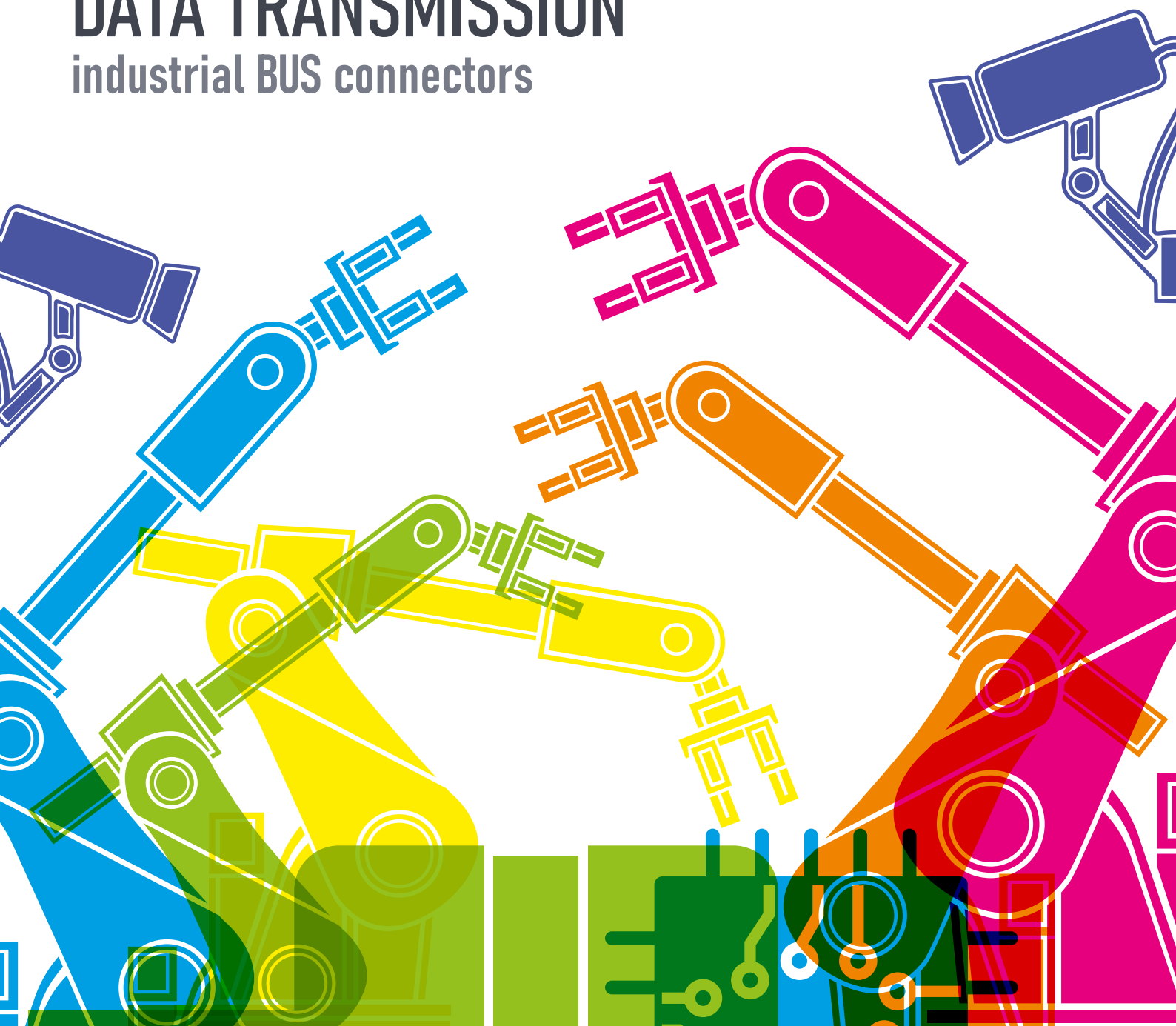

**min-tec**<sup>®</sup>

We connect your Innovation

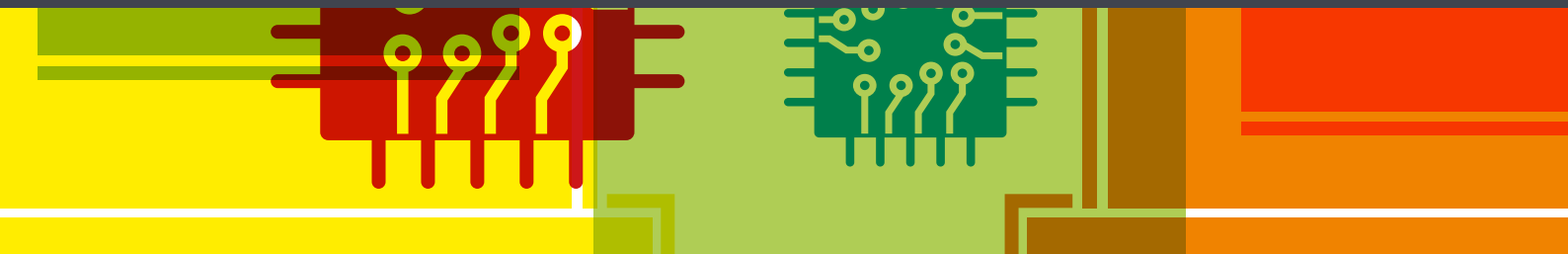



## RELIABILITY IN HARSH ENVIRONMENTS WITH MINTEC

Mintec experience in the fields of industrial and outdoor connection finds its maximum expression in the creation of connectors for **data transmission**. Thanks to the choice of materials and attention to details, the communication between devices is reliable even in the most extreme environments, in presence of strong vibrations, temperature variations, dust and liquids.



### TPU (PUR) MOULDED BODY

Mintec is specialized in molding of Poly-ether Polyurethane. This typology of TPU ensures many advantages:

- > Abrasion resistance
- > High low temperature flexibility
- > Excellent hydrolytic stability
- > Oils, Fuels and Solvent Resistance

### TURNED THREADED RINGS

The M12 ring nuts are turned nickel plate brass with self-locking system. The integrated hexagonal profile allows the use of a torque wrench for a perfect match.

### PRESS-FIT TECHNOLOGY

These female pins for M12 include a specific ring for clipping the male pins, maintaining a stable contact even with strong vibrations and mechanical stresses. This feature guarantees that there is no possibility to lose the connection in every extreme conditions.

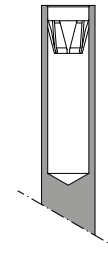
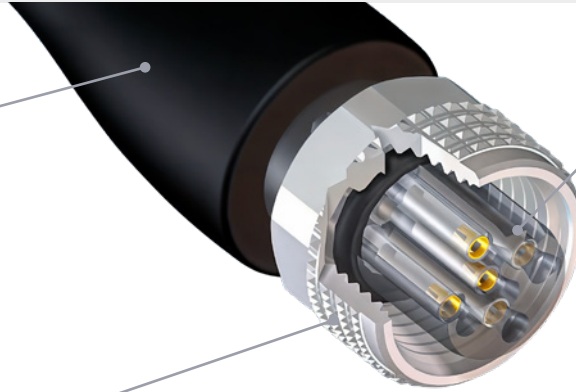

## COMPLETE ETHERNET PRODUCT RANGE

Ethernet-based communication is more and more widespread, Mintec has developed a complete range of products to ensure speed and reliability.

- > M12 D code family product for Profinet, Ethernet/IP
- > M12 X code for Gigabit Ethernet up to 10 Gbit/s
- > M8 A code and D code for EtherCAT and Profinet

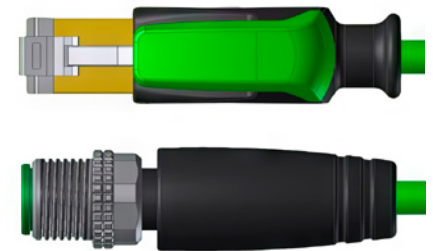

## LONG TIME EXPERIENCE IN CAN APPLICATIONS

CANopen and DeviceNET protocols are used both in industrial automation and in automotive, mobile and special vehicles applications. Thanks to our cabling and hub distributor solutions, Mintec is recognized as an industry leader in the market of mobile applications.

- > M12 A code complete range connectors for CAN and DeviceNET protocols
- > Passive HUB distributors for star topology and daisy chain BUS connection

## HIGH QUALITY PUR CABLES

Industrial Ethernet-Profinet	Industrial Ethernet SF/UTP	Gigabit Ethernet S/FTP	CAN bus	DeviceNET
CAT5e 4xAWG22 UL style	CAT5e 4xAWG26 UL style	CAT7 4x(2xAWG26) UL style	2x2xAWG22 UL style	1x2xAWG22 + 1x2xAWG24 UL style
PUR 80°C/30V	PUR 80°C/30V	PUR 80°C/30V	PUR 80°C/30V	PUR 80°C/30V

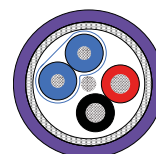
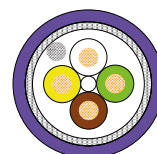
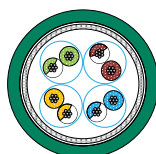
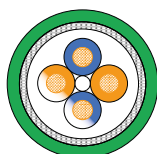
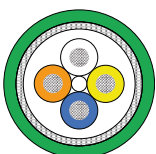



Length	male straight RJ45	male straight M12 D code	Length	double ended RJ45	double ended RJ45, M12	double ended M12
<b>4xAWG22 CAT5e Industrial Ethernet Type C</b>						
2m	43983-000	43873-000	0.3m	44985-300	44975-300	44965-300
5m	43983-002	43873-002	0.6m	44985-301	44975-301	44965-301
10m	43983-010	43873-003	1.5m	44985-302	44975-302	44965-302



Length	male straight M8 A code	Length	double ended RJ45, M8	double ended M8 m/m
<b>4xAWG26 CAT5e Industrial Ethernet</b>				
2m	41603-020	0.3m	42613-003	42603-003
5m	41603-050	0.6m	42613-006	42603-006
10m	41603-100	1.5m	42613-015	42603-015



Length	male straight RJ45	male straight M12 X code	Length	double ended RJ45	double ended RJ45, M12	double ended M12
<b>4x(2xAWG26) CAT 7 Industrial Ethernet</b>						
2m	43993-000	43963-000	0.3m	44981-300	44972-300	44950-300
5m	43993-002	43963-002	0.6m	44981-301	44972-301	44950-301
10m	43993-010	43963-003	1.5m	44981-302	44972-302	44950-302



Length	male straight M12 A code	female straight M12 A code	male angled M12	female angled M12	Length	double ended M12
<b>2x2xAWG22 PUR UL Violet cable</b>						
2m	43773-000	43753-000	43783-000	43763-000	0.3m	44850-300
3m	43773-001	43753-001	43783-001	43763-001	0.6m	44850-301
5m	43773-002	43753-002	43783-002	43763-002	1.5m	44850-302

Length	male straight M12 A code	female straight M12 A code	male angled M12	female angled M12	Length	double ended M12
<b>1x2xAWG22 + 1x2xAWG24 PUR UL Violet cable</b>						
2m	43923-000	43903-000	43933-000	43913-000	0.3m	44940-300
3m	43923-001	43903-001	43933-001	43913-001	0.6m	44940-301
5m	43923-002	43903-002	43933-002	43913-002	1.5m	44940-302

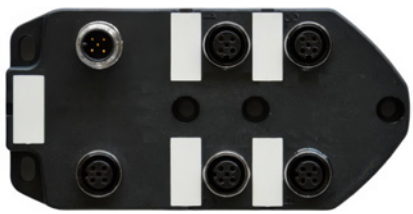

M12 Passive HUB

distribution system for CanOpen/Devicenet 4 ports + IN/OUT  
47209-000

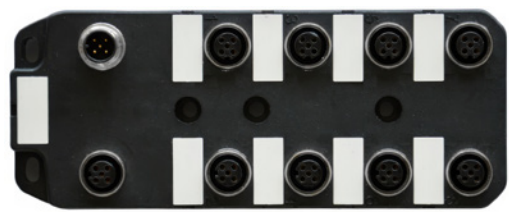

M12 Passive HUB

distribution system for CanOpen/Devicenet 8 ports + IN/OUT  
47209-002



	male M12	female M12	male receptacle	female receptacle	Industrial RJ45
Dcode	46800-002	46820-002	46912-000	46852-000	
Acode	46770-002	46710-002	46956-000	46896-000	060408046



## Mintec - Creativity, Passion, Innovation. "The Quality Connection"

Our long and consolidated experience in the connection sector, combined with our passion and creativity, have led us to create quality products that are highly appreciated in the "outdoor" sectors: connectors suitable for heavy-duty applications, where resistance and continuity of service are required, even when subjected to significant stress, vibrations, large temperature ranges, in the continuous presence of dust and liquids.

We transfer this know-how to our products on a daily basis, with consequent advantages in addition to the basic characteristics found in more widely used products, guaranteeing, for example, compliance with IP67 on all products and IP68 where the customer requires it.

Our connectors are therefore developed, manufactured and marketed with the expertise and passion that sets us apart and is expressed in the product itself.

As certified operators, we work in compliance with ISO 9001:2015 standards. Furthermore, being in close contact with the main certification bodies for the Approvals of its products, Mintec offers numerous products with the UL mark. All this in a "Green" context that sees our company working in energy autonomy thanks to its own photovoltaic system.

Mintec means Quality also in the customer service, from the initial activities of support to the connection project, to the customisation of the product or the simple choice of the standard connector, up to a careful after-sales service.



Mintec Industriale S.r.l.

Via Vallassina, 1/3 22060 - AROSIO (CO) - ITALY

Phone: +39 031 760911 r.a.

Fax: +39 031 762733

[www.mintec.it](http://www.mintec.it)

[info@mintec.it](mailto:info@mintec.it)

